

Article number: 12318000040100

Description: KLEE-coil 318 000 040.100
M4 Unhardened steel slotted pin

Measures

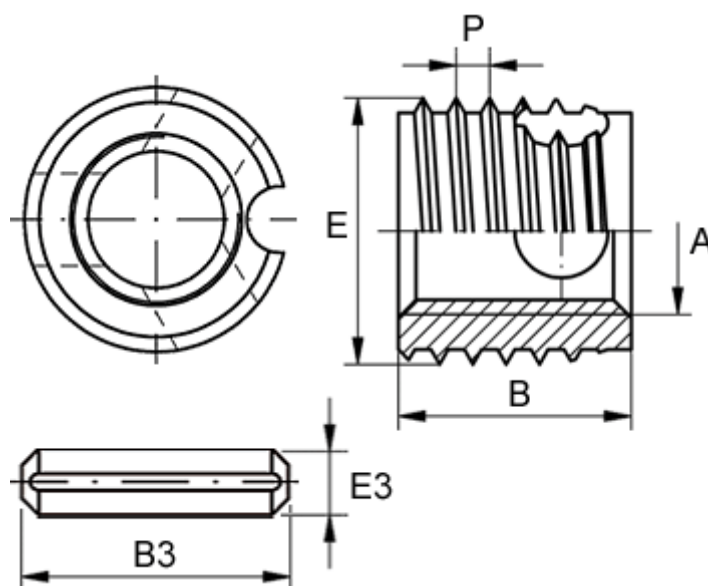

Female thread A	= M4
Length B	= 8
Male thread E	= 6.5
Min hole depth blind hole	= 10
Slotted pin B3	= 6
Slotted pin E3	= 2
Thread pitch P	= 0.80
Type	= 318 000 040 ...